

--	--

LCM Specification

PRODUCT TYPE:	5.0TFT SerialModule
PRODUCT P/N:	FBS050BT01-R02-SPEC
VERSION:	V00

Customer (客户)		
INSPECTION RESULT 检测结果	TESTED BY 检测人	APPROVED BY 确认人

Supplier(屏厂)		
DESIGNED BY	CHECKED BY	APPROVED BY

--	--

Revision History

Date	Rev.	Reason
2021.04.18	V00	NEW ISSUE

--	--

CONTENTS

- GENERAL DESCRIPTION
- LCM PARAMETER
- SERIAL CHARACTERISTIC
- ABSOLUTE MAXIMUM RATINGS
- ELECTRICAL SPECIFICATIONS
- BACKLIGHT CHARACTERISTICS
- BLOCK DIAGRAM
- PIN DESCRIPTION
- OUTLINE DIMENSION
- OPTICAL SPECIFICATIONS
- TIMING CHARACTERISTICS
- TFT serial screen protocol table without master terminal
- INSPECTION CRITERION
- PRECAUTIONS

--	--

■ GENERAL DESCRIPTION

FSD050BT01-R02 is a TFT dot matrix LCD module. It is composed of a PCBA, color-LCD panel, driver IC, FPC, RTP and a backlight unit. The module display area contains **480x272** pixels. This product accords with RoHS environmental criterion.

■ LCM PARAMETER

Item	Contents	Unit	Notes
LCD Type	TFT TRANSMISSIVE	/	/
Viewing direction	6:00	O' Clock	/
PCBA Outside	143.50(W)*80.90(H)*13.00(T)	mm	/
LCM Outside Dimensions	120.70(W)*76.00(H)*3.00(T)	mm	/
Active Area (WxH)	108.00(W)*64.80(H)	mm	/
Number of Dots	480x272	/	/
Driver IC	LT7689	/	Vcc=3.3V
Colors	16.7M	/	/
Touch Type	NO USE	/	/
Backlight Type	6*2=12LEDS / White	/	Vbl=18.6V
Backlight Luminance	350	cd/m2	/
Interface Type	RS232 (TTL UART)	/	4PIN(2.54)
Input Voltage	5.0V or 12V (VDD)	V	2A

■ SERAL CHARACTERISTIC

Item	MIN	Typical	MAX	Unit	Notes
Operating Voltage	4.75	5.0	5.5	V	VDD
Operating Current	---	400	---	mA	5V Power
Operating Temperature	-20	25	70	° C	/
Storage Temperature	-30	25	80	° C	/
Serial Baud rate	2400	9600	115200	bps	Standards
Serial Output Leve	3.0	3.2	3.3	V	H
Serial Input Leve	3.0	3.3	5.0	V	H
Extend Flash	64M	128M	2G	bits	Nor/Nand
Display RAM	---	128M	---	Bytes	MCU
FlashMemory	---	512K	---	Bytes	MCU
SRAMMemory	---	256K	---	Bytes	MCU
MCU Frequency	---	150M	---	Hz	MCU

--	--

■ ABSOLUTE MAXIMUM RATINGS(TFT,非PCBA)

Parameter	Symbol	Min	Max	Unit
Power for Circuit Driving	VCC	-0.3	4.6	V
Power for Circuit Logic	IOVCC	-0.3	4.6	V
Input voltage	Vin	-0.3	VCC + 0.3	V
Operating temperature	Top	-20	70	℃
Storage temperature	Tst	-30	80	℃
Humidity	RH	/	90%(Max60℃)	RH

■ ELECTRICAL SPECIFICATIONS(TFT,非PCBA)

Parameter	Symbol	Min	Typ	Max	Unit
Power for analog/logic	Vcc -GND	2.65	3.3	3.6	V
I/O power supply	IOVCC	1.65	3.3	3.6	V
Input Current	Idd	TBD	TBD	TBD	mA
Input voltage ' H ' level	Vih	0.7IOVCC	/	IOVCC	V
Input voltage ' L ' level	Vil	GND	0	0.3IOVCC	V
Output voltage ' H ' level	Voh	0.8IOVCC	/	IOVCC	V
Output voltage ' L ' level	Vol	GND	0	0.2IOVCC	V

■ BACKLIGHT CHARACTERISTICS

Using condition: constant current driving method (If=40mA(+/-10%))

Item	Symbol	Min	Typ	Max	Unit	Condition
Forward voltage	Vf	18.0	18.6	19.2	V	If=40mA
Luminance with LCD	Lv	--	350	--	cd/m ²	/
Number of LED	/	6*2 = 12			Pcs	/
Connection mode	S	6 Serial 2 Parallel			/	/



■ BLOCK DIAGRAM

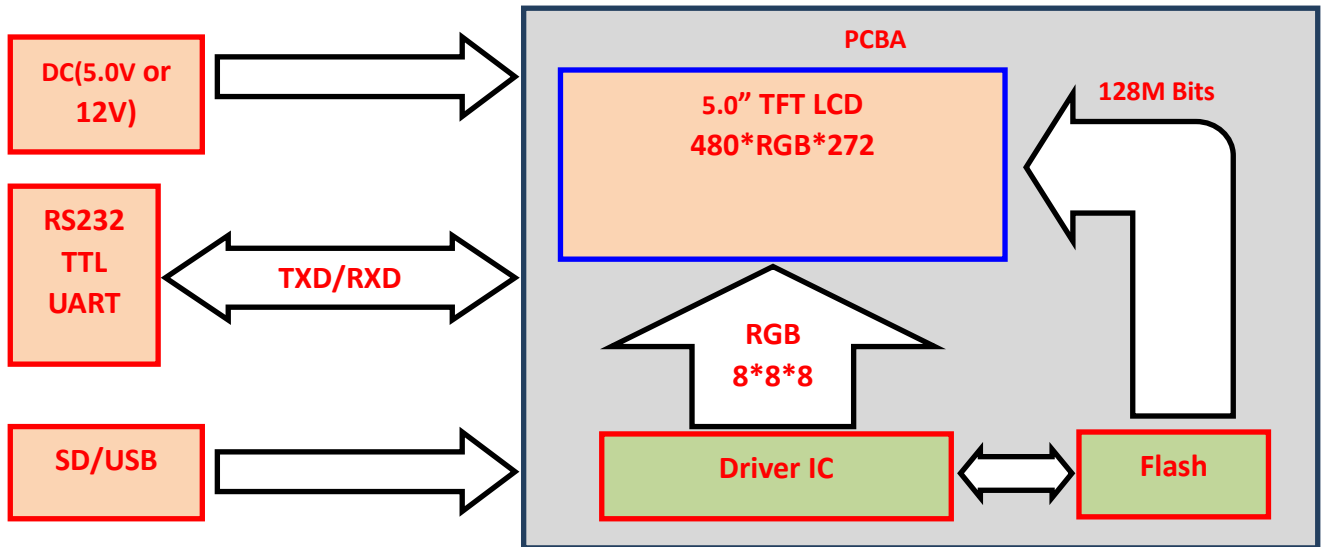

■ PIN DESCRIPTION

CN1: RS232 or TTL UART (8PIN-2.5mm)

Pin.No	Symbol	DESCRIPTION
1	VDD	Power Supply Voltage(5.0V+/-0.3V)
2	VDD	Power Supply Voltage(5.0V+/-0.3V)
3	BUSY	Not Defined
4	Dout	RS232 or TTL UART transmit data output
5	Din	RS232 or TTL UART receiving data input
6	Din	RS232 or TTL UART receiving data input
7	GND	Ground
8	GND	Ground

CN2: RS232 or TTL UART (10PIN-0.5mm)

Pin.No	Symbol	DESCRIPTION
1	VDD	Power Supply Voltage(5.0V+/-0.3V)
2	VDD	Power Supply Voltage(5.0V+/-0.3V)
3	VDD	Power Supply Voltage(5.0V+/-0.3V)
4	BUSY	Not Defined
5	Dout	RS232 or TTL UART transmit data output
6	Din	RS232 or TTL UART receiving data input
7	Din	RS232 or TTL UART receiving data input
8	GND	Ground
9	GND	Ground
10	GND	Ground

--	--

CN3: CTP (10PIN)

Standard (NC)

CN4: RTP (4PIN)

Standard (NC)

CN5: TFT+RTP (40PIN)

Standard

CN6:SD Upgrade (Standard)

Pin.No	Symbol	DESCRIPTION
1	DATD2	Data2
2	DATD3 (SS3)	Chip selection signal
3	CMD (MOSI3)	Data output signal
4	VCC	SD Power Supply Voltage (3.3V+/-0.3V)
5	CLK	Clock Signal
6	VSS	Ground
7	DAT0 (MISO3)	Data input signal
8	DAT1	Data1
9	ON/OFF (SD_IN)	Wake-up input

CN7:USB Upgrade (Standard)

Pin.No	Symbol	DESCRIPTION
1	VDD	Power Supply Voltage (5.0V+/-0.3V)
2	DM	USB Data Terminal (Positive)
3	DP	USB Data Terminal (Negative)
4	GND	Ground
5	GND	Ground

CN8: MCU Debug (3PIN)

Standard (Customers no use) OTG: H (USB Upgrade) ; OTG: L (SD Upgrade)

CN10: WIFI Reserve (4PIN)

Standard (Customers no use)

CN11: Audio Speaker interface (2PIN)

Standard (Customers no use)



OUTLINE DIMENSION

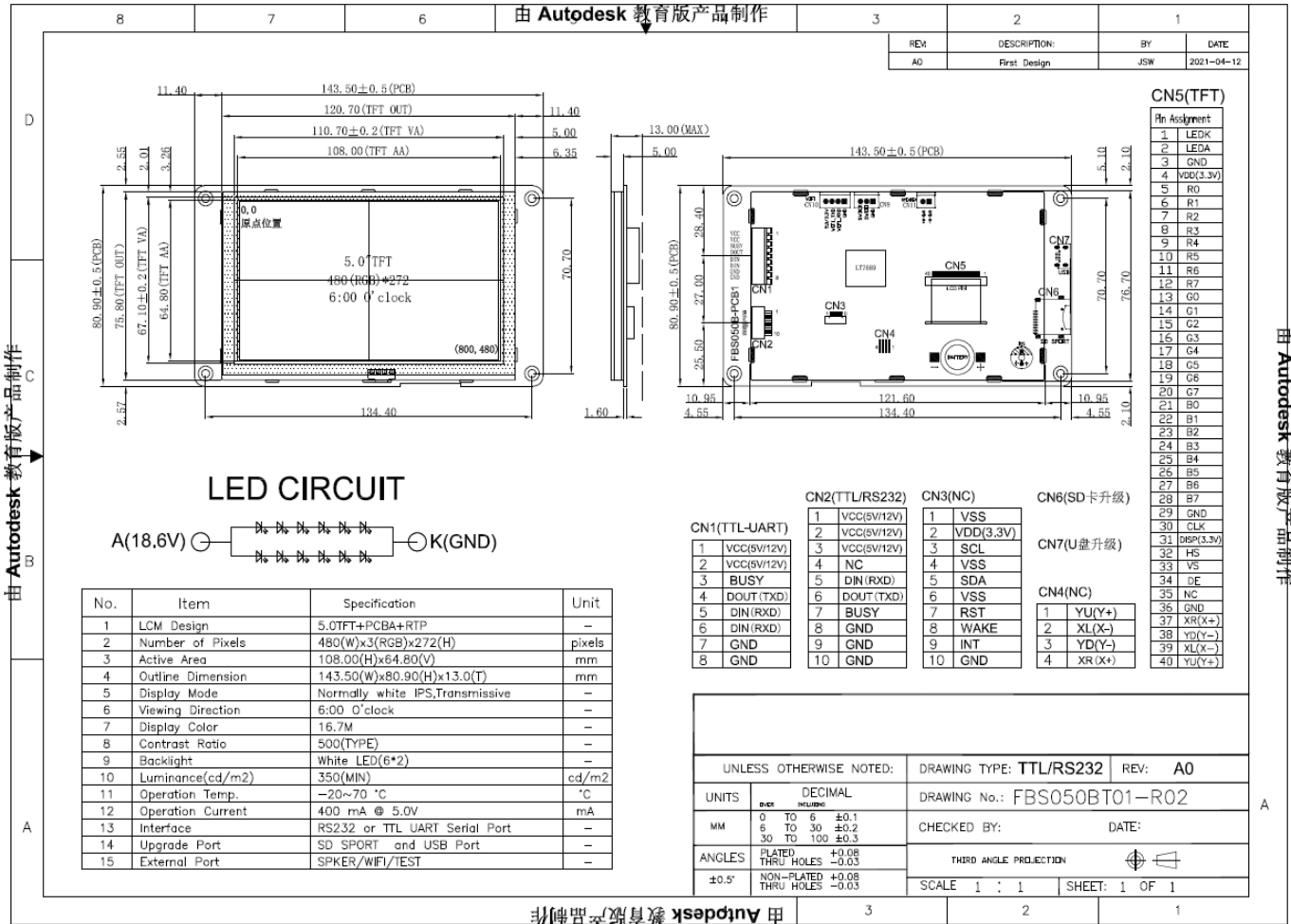

--	--

■ OPTICAL SPECIFICATIONS

Item	Symbol	Condition	Min	Typ	Max	Unit	Note
Response time	Tr+Tf	$\theta=0^\circ$ $\Phi=0^\circ$ $T_a=25^\circ\text{C}$	-	20	40	ms	/
Contrast ratio	Cr		-	500	-	-	/
Luminanceuniformity	δ WHITE		80	-	-	%	/
Viewing angle range	θ	$\Phi=0^\circ$	50	60	-	deg	/
		$\Phi=90^\circ$	30	40	-	deg	
		$\Phi=180^\circ$	50	60	-	deg	
		$\Phi=270^\circ$	50	60	-	deg	
CIE(x,y) chromaticity	Red	x	-	0.610	-	/	/
		y	-	0.329	--		
	Green	x	-	0.299	-		
		y	-	0.567	-		
	Blue	x	-	0.143	-		
		y	-	0.111	-		
	White	x	-	0.308	-		
		y	-	0.327	-		

Definition of Viewing Angle θ and Φ

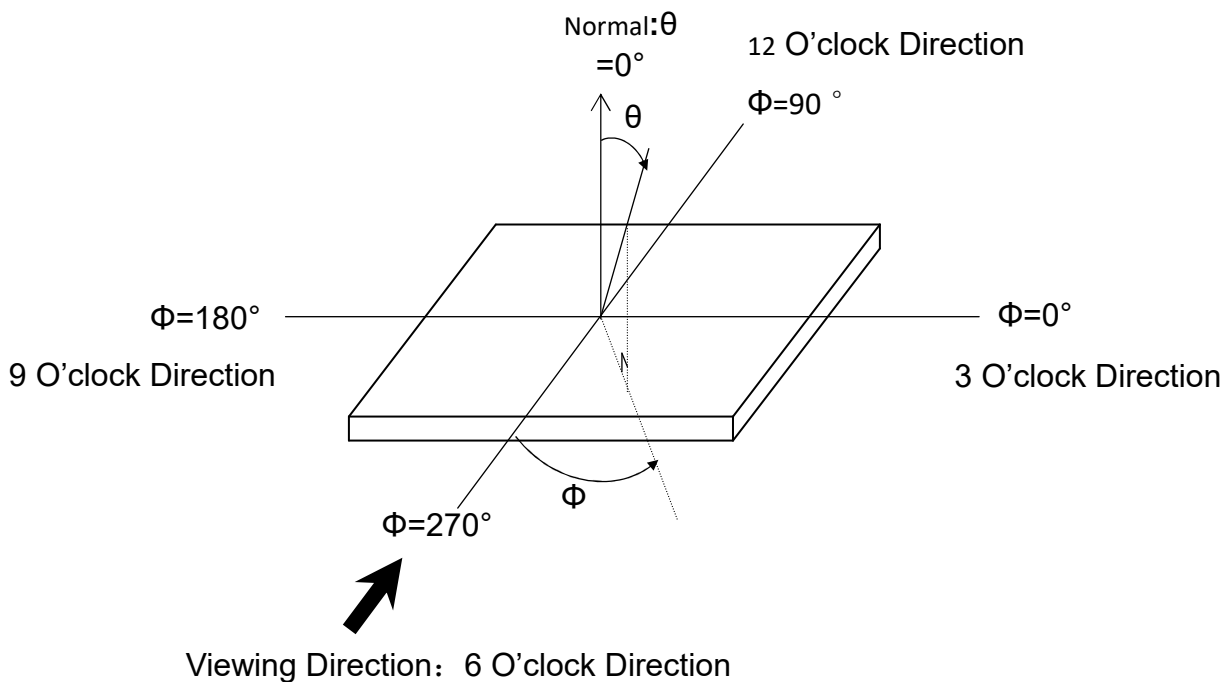

--	--

■ TIMING CHARACTERISTICS

TBD

■ TFT serial screen protocol table without master terminal

主功能	细项功能	主控端发送 (TFT 串口屏接收)						主控端接收 (TFT 串口屏发送)					
		起始码 (1Bytes)	指令码 (1Byte)	序号 (1Byte)	指令参数	CRC 码 (2Bytes)	结束码 (4Bytes)	起始码 (1Bytes)	指令码 (1Byte)	序号 (1Byte)	信息码/ 反馈码 (1Bytes)	CRC 码 (2Bytes)	结束码 (4Bytes)
显示图片	单张/ 多张图片	Start	80h	nn		CRC	End	Start	80h	nn	信息码	CRC	End
	单张/ 多张图片	Start	8Ah	nn		CRC	End	Start	8Ah	nn	信息码	CRC	End
	单张图片	Start	8Fh	nn	X, Y, PNG, Pnn	CRC	End	Start	8Fh	nn	信息码	CRC	End
	循环播放	Start	81h	nn		CRC	End	Start	81h	nn	信息码	CRC	End
	取消循环 播放	Start	84h	nn		CRC	End	Start	84h	nn	信息码	CRC	End
	透明图片	Start	82h	nn		CRC	End	Start	82h	nn	信息码	CRC	End
	GIF 动画	Start	88h	nn		CRC	End	Start	88h	nn	信息码	CRC	End
	取消 GIF 动画	Start	89h	nn		CRC	End	Start	89h	nn	信息码	CRC	End
	设定缓冲区	Start	8Eh		0, 1	CRC	End	Start	8Eh	00	信息码	CRC	End
	弹出图片	Start	D8h	nn		CRC	End	Start	D8h	nn	信息码	CRC	End
	循环卷动	Start	D9h	nn		CRC	End	Start	D9h	nn	信息码	CRC	End
	取消循环 卷动	Start	DBh	nn		CRC	End	Start	DBh	nn	信息码	CRC	End
	数字图片-1	Start	90h	nn	ddd.d	CRC	End	Start	90h	nn	信息码	CRC	End
	真彩数字图 片	Start	91h	nn	ddd.d	CRC	End	Start	91h	nn	信息码	CRC	End
	显示控件图片	全屏滑动 图片	Start	B4h	nn		CRC	End	Start	B4h	Nn	信息码	CRC
显示单一控 件图片		Start	A0h	nn		CRC	End	Start	A0h	Nn	信息码	CRC	End
		按下控件图片时						Start	A0h	Nn	31h	CRC	End
放开控件图片时						Start	A0h	Nn	30h	CRC	End		
取消单一 控件图片		Start	A1h	nn		CRC	End	Start	A1h	Nn	信息码	CRC	End
虚拟控件		Start	A2h	nn		CRC	End	Start	A2h	nn	信息码	CRC	End
		按下控件区域时						Start	A2h	nn	31h	CRC	End
放开控件区域时						Start	A2h	nn	30h	CRC	End		
取消虚拟控 件		Start	A3h	nn		CRC	End	Start	A3h	nn	信息码	CRC	End
显示底图 及所有控 件图片		Start	9Ch	00		CRC	End	Start	9Ch	00	信息码	CRC	End
	屏幕滑动后						Start	9Ch	页号	信息码	CRC	Start	
	按下控件图片时						Start	98h	图标 ID 号	31h	CRC	End	
放开控件图片时						Start	98h	图标 ID 号	30h	CRC	End		

--	--

主功能	细项功能	主控端发送 (TFT 串口屏接收)						主控端接收 (TFT 串口屏发送)					
		起始码 (1Bytes)	指令码 (1Byte)	序号 (1Byte)	指令参数	CRC 码 (2Bytes)	结束码 (4Bytes)	起始码 (1Bytes)	指令码 (1Byte)	序号 (1Byte)	信息码/ 反馈码 (1Bytes)	CRC 码 (2Bytes)	结束码 (4Bytes)
指标与造图	进度条 指标图	Start	B0h	nn	Value (2 Bytes)	CRC	End	Start	B0h	nn	信息码	CRC	End
	指针指标图	Start	B1h	nn	Angle (2 Bytes)	CRC	End	Start	B1h	nn	信息码	CRC	End
	环形指标图	Start	DCh	nn	S_Angle, A_Angle	CRC	End	Start	DCh	nn	信息码	CRC	End
	二维码生成	Start	98h	nn	字符串	CRC	End	Start	98h	nn	信息码	CRC	End
触控滑条控制	设置触控 滑条	Start	94h	nn		CRC	End	Start	94h	nn	信息码	CRC	End
		触控滑条被按下时						Start	94h	nn	Value (1 Byte)	CRC	End
	移除触控 滑条	Start	95h	nn		CRC	End	Start	95h	nn	信息码	CRC	End
	设置环形触 控滑条	Start	96h	nn		CRC	End	Start	96h	nn	信息码	CRC	End
		环形触控滑条被按下时						Start	96h	nn	Value (1 Byte)	CRC	End
显示字符串	移除环形触 控滑条	Start	97h	nn		CRC	End	Start	97h	nn	信息码	CRC	End
	字库-1	Start	C0h	nn	字符串	CRC	End	Start	C0h	nn	信息码	CRC	End
	字库-2	Start	C1h	nn	字符串	CRC	End	Start	C1h	nn	信息码	CRC	End
	字库-3	Start	C2h	nn	字符串	CRC	End	Start	C2h	nn	信息码	CRC	End
	字库-4	Start	C3h	nn	字符串	CRC	End	Start	C3h	nn	信息码	CRC	End
	大字库-1	Start	D0h	nn	字符串	CRC	End	Start	D0h	nn	信息码	CRC	End
	大字库-2	Start	D1h	nn	字符串	CRC	End	Start	D1h	nn	信息码	CRC	End
	大字库-3	Start	D2h	nn	字符串	CRC	End	Start	D2h	nn	信息码	CRC	End
大字库-4	Start	D3h	nn	字符串	CRC	End	Start	D3h	nn	信息码	CRC	End	
图形光标	光标 On/Off	Start	86h		00/01/02	CRC	End	Start	86h	nn	信息码	CRC	End
	显示光标	Start	87h	N	X, Y	CRC	End	Start	87h	N	信息码	CRC	End
背光亮度	设置亮度	Start	BAh		BL (00~0Fh)	CRC	End	Start	BAh	BL (00~0Fh)	信息码	CRC	End
	On/Off	Start	BCh		00 或 01	CRC	End	Start	BCh	00 或 01	信息码	CRC	End
Wav 檔	播放	Start	B8h		REP(Bit7) + WAV 编 号	CRC	End	Start	B8h	REP(Bit7) + WAV 编 号	信息码	CRC	End
	停止	Start	B9h			CRC	End	Start	B9h	00	信息码	CRC	End
开机指令	开机指令	Start	9Ah	00		CRC	End	Start	9Ah	00	信息码	CRC	End
合并指令	合并指令	Start	9Ah	nn		CRC	End	Start	9Ah	nn	信息码	CRC	End
设定 时钟	设定时钟	Start	8Ch		Y, M, D, H, M, S, W (7 Bytes)	CRC	End	Start	8Ch	00	信息码	CRC	End
	读取时钟	Start	8Dh			CRC	End	Start	8Dh	Y, M, D, H, M, S, W (8)	信息码	CRC	End

--	--

主功能	细项功能	主控端发送 (TFT 串口屏接收)						主控端接收 (TFT 串口屏发送)					
		起始码 (1Bytes)	指令码 (1Byte)	序号 (1Byte)	指令参数	CRC 码 (2Bytes)	结束码 (4Bytes)	起始码 (1Bytes)	指令码 (1Byte)	序号 (1Byte)	信息码/ 反馈码 (1Bytes)	CRC 码 (2Bytes)	结束码 (4Bytes)
电阻屏校验	电阻屏校验	Start	88h			CRC	End	Start	88h	00	信息码	CRC	End
复位	Reset LT7689	Start	BDh			CRC	End	Start	BDh	00	信息码	CRC	End
几何图形	画点	Start	DFh	nn	X,Y	CRC	End	Start	DFh	nn	信息码	CRC	End
	直线	Start	E0h	nn		CRC	End	Start	E0h	nn	信息码	CRC	End
	空心圆形	Start	E1h	nn		CRC	End	Start	E1h	nn	信息码	CRC	End
	实心圆形	Start	E2h	nn		CRC	End	Start	E2h	nn	信息码	CRC	End
	带框实心圆形	Start	E3h	nn		CRC	End	Start	E3h	nn	信息码	CRC	End
	空心椭圆	Start	E4h	nn		CRC	End	Start	E4h	nn	信息码	CRC	End
	实心椭圆	Start	E5h	nn		CRC	End	Start	E5h	nn	信息码	CRC	End
	带框实心椭圆	Start	E6h	nn		CRC	End	Start	E6h	nn	信息码	CRC	End
	空心矩形	Start	E7h	nn		CRC	End	Start	E7h	nn	信息码	CRC	End
	实心矩形	Start	E8h	nn		CRC	End	Start	E8h	nn	信息码	CRC	End
	带框矩形	Start	E9h	nn		CRC	End	Start	E9h	nn	信息码	CRC	End
	空心圆角矩形	Start	EAh	nn		CRC	End	Start	EAh	nn	信息码	CRC	End
	实心圆角矩形	Start	EBh	nn		CRC	End	Start	EBh	nn	信息码	CRC	End
	带框圆角矩形	Start	ECh	nn		CRC	End	Start	ECh	nn	信息码	CRC	End
	空心三角形	Start	EDh	nn		CRC	End	Start	EDh	nn	信息码	CRC	End
	实心三角形	Start	EEh	nn		CRC	End	Start	EEh	nn	信息码	CRC	End
	带框三角形	Start	EFh	nn		CRC	End	Start	EFh	nn	信息码	CRC	End
	空心四边形	Start	F0h	nn		CRC	End	Start	F0h	nn	信息码	CRC	End
	实心四边形	Start	F1h	nn		CRC	End	Start	F1h	nn	信息码	CRC	End
	空心五边形	Start	F2h	nn		CRC	End	Start	F2h	nn	信息码	CRC	End
	实心五边形	Start	F3h	nn		CRC	End	Start	F3h	nn	信息码	CRC	End
	圆柱体	Start	F4h	nn		CRC	End	Start	F4h	nn	信息码	CRC	End
	方柱体	Start	F5h	nn		CRC	End	Start	F5h	nn	信息码	CRC	End
	表格视窗	Start	F6h	nn		CRC	End	Start	F6h	nn	信息码	CRC	End

--	--

主功能	细项功能	主控端发送 (TFT 串口屏接收)						主控端接收 (TFT 串口屏发送)					
		起始码 (1Bytes)	指令码 (1Byte)	序号 (1Byte)	指令参数	CRC 码 (2Bytes)	结束码 (4Bytes)	起始码 (1Bytes)	指令码 (1Byte)	序号 (1Byte)	信息码/ 反馈码 (1Bytes)	CRC 码 (2Bytes)	结束码 (4Bytes)
数字键盘	数字键盘输入	Start	A4h	00		CRC	End	Start	A4h	nn	信息码	CRC	End
		按下数字键后						Start	A4h	nn	ASCII + 信息码	CRC	End
		按下 CR 键后						Start	A4h	nn	ASCII + 信息码 + 内容	CRC	End
	取消数字键盘	Start	A5h	00		CRC	End	Start	A5h	nn	信息码	CRC	End
串口屏 侦测	联机检查	Start	BEh			CRC	End	Start	BEh	00	5Ah, or 55h	CRC	End
	版本检查	Start	BFh			CRC	End	Start	BFh	MCU Code(5) + Module Info. (42)	信息码	CRC	End

--	--

■ INSPECTION CRITERION

Sampling Method

Unless otherwise agreed upon in writing, the sampling inspection shall be applied to the Customer's incoming inspection.

- 1 Lot size: Quantity per shipment lot
- 2 Sampling type: Normal inspection , single sampling
- 3 Inspection level: II
- 4 Sampling table: MIL-STD-105D
- 5 Acceptable Quality Level(AQL): Major=0.65 Minor=1.5

Inspection Method

- 1) Ambient Condition:
 - a. Temperature: Room temperature $25 \pm 5^{\circ}\text{C}$
 - b. Illumination: Single fluorescent lamp non-directive(300 to 700 Lux)
- 2) Viewing distance
The distance between the LCD and the inspector' s eyes shall be at least 30-50cm.
- 3) Viewing Angle
The inspection shall be conducted within normal viewing angle range.

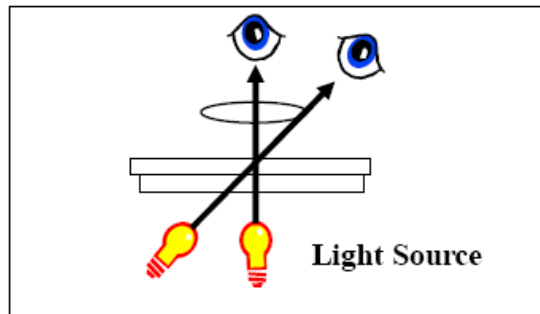



Major Defect

No	Items	Inspection Standard	Classification of defects
1	All functional defects	1.No display 2.Display abnormally 3.Missing vertical, horizontal segment 4.Short circuit 5. Back-light no lighting, flickering and abnormal lighting.	Major
2	Missing	Missing component	
3	Outline dimension	Overall outline dimension beyond the drawing is not allowed.	
4	linearity	No more than 1.5%	

--	--

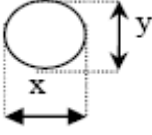
Cosmetic Defect

No	Items	Inspection Standard	Classification of defects	
1	Clear Spot, Black Spot, white Spot, defect Pinhole, Foreign Particle, polarizer Dirt TP Dirt	For dark/white spot, size Φ is defined as $\Phi=(x+y)/2$ 	Minor	
		Size(mm)		Acceptable Qty
		$\Phi \leq 0.15$		Ignore
		$0.15 < \Phi \leq 0.20$		2
		$0.20 < \Phi \leq 0.30$		1
		$\Phi > 0.30$		0
2	(line defect) Black and White line Polarizer scratch	Define: 	Minor	
		Width(mm)		Length(mm); Acceptable Qty
		$W \leq 0.03$		Ignore
		$0.03 < W \leq 0.05$		$L \leq 3.0; N \leq 2$
		$0.05 < W \leq 0.1$		$L \leq 2.0; N \leq 2$
		$0.1 < W$		Define as spot defect
3	Dim Spots Circle shaped and dim edged defects	/	Minor	
		Size(mm)		Acceptable Qty
		$\Phi \leq 0.2$		Ignore
		$0.20 < \Phi \leq 0.40$		2
		$0.40 < \Phi \leq 0.60$		1
		$\Phi > 0.60$		0

--	--

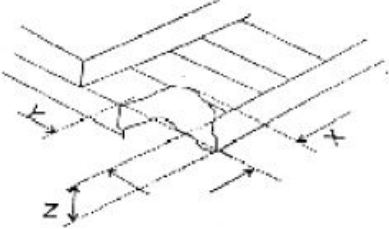
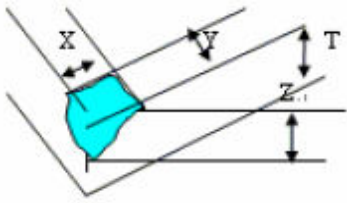
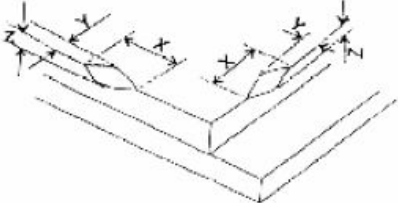
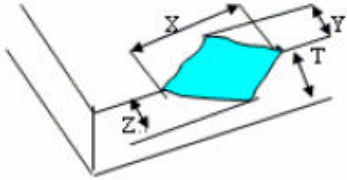
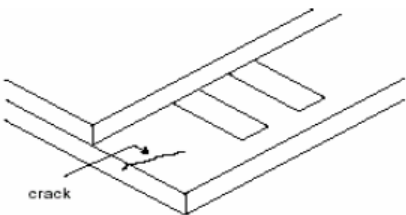
No	Items	Inspection Standard	Classification of defects						
4	Glass defect TP defect	<p>(1) Chips on corner (A:LCD Glass defect)</p>  <table border="1" data-bbox="844 405 1214 551"> <thead> <tr> <th>X(mm)</th> <th>Y(mm)</th> <th>Z(mm)</th> </tr> </thead> <tbody> <tr> <td>≤2.0</td> <td>≤S</td> <td>Disregard</td> </tr> </tbody> </table> <p>Notes: S=contact pad length Chips on the corner of terminal shall not be allowed to extend into the ITO pad or expose perimeter seal.</p>	X(mm)	Y(mm)	Z(mm)	≤2.0	≤S	Disregard	Minor
		X(mm)	Y(mm)	Z(mm)					
		≤2.0	≤S	Disregard					
		<p>(2) Chips on corner (TP Glass defect)</p>  <table border="1" data-bbox="844 842 1214 987"> <thead> <tr> <th>X(mm)</th> <th>Y(mm)</th> <th>Z(mm)</th> </tr> </thead> <tbody> <tr> <td>≤3.0</td> <td>≤3.0</td> <td>Disregard</td> </tr> </tbody> </table>	X(mm)	Y(mm)	Z(mm)	≤3.0	≤3.0	Disregard	
		X(mm)	Y(mm)	Z(mm)					
≤3.0	≤3.0	Disregard							
<p>(3) Usual surface cracks (LCD Glass defect)</p>  <table border="1" data-bbox="443 1335 1171 1424"> <thead> <tr> <th>X(mm)</th> <th>Y(mm)</th> <th>Z(mm)</th> </tr> </thead> <tbody> <tr> <td>≤3.0</td> <td><Inner border line of the seal</td> <td>Disregard</td> </tr> </tbody> </table>	X(mm)	Y(mm)	Z(mm)	≤3.0	<Inner border line of the seal	Disregard			
X(mm)	Y(mm)	Z(mm)							
≤3.0	<Inner border line of the seal	Disregard							
<p>(4) Usual surface cracks (TP Glass defect)</p>  <table border="1" data-bbox="443 1693 1171 1783"> <thead> <tr> <th>X(mm)</th> <th>Y(mm)</th> <th>Z(mm)</th> </tr> </thead> <tbody> <tr> <td>≤6.0</td> <td><2.0</td> <td>Disregard</td> </tr> </tbody> </table>	X(mm)	Y(mm)	Z(mm)	≤6.0	<2.0	Disregard			
X(mm)	Y(mm)	Z(mm)							
≤6.0	<2.0	Disregard							
<p>(5) Crack (Cracks tend to break are not allowed.)</p> 									

--	--

■ RELIABILITY

NO.	TEST ITEM	CONDITIONS
1	High Temperature Storage	80°C; 72hrs
2	Low Temperature Storage	-30°C; 72hrs
3	HighTemperature Operation	70°C; 72hrs
4	Low Temperature Operation	-20°C; 72hrs
5	High Temperature and HighHumidity Operation	50°C, 90% RH; 120 hrs
6	Thermal shock(Storage)	-20°C(0.5Hr)→70°C(0.5Hr) 100 Cycles

NOTE:

1. All judgement of display are performed after temperature of panel return to room temperature.
2. Display function should be no change under normal operating condition.
3. Under no condensation of dew.
4. WE only guarantee the above 6 test items, and without guarantee the others.

■ PRECAUTIONS

Handing Precautions

- (1) The display panel is made of glass and polarizer. As glass is fragile, it tends to become or chipped during handling especially on the edges. Please avoid dropping or jarring. Do not subject it to a mechanical shock by dropping it or impact.
- (2) If the display panel is damaged and the liquid crystal substance leaks out, be sure not to get any in your mouth. If the substance contacts your skin or clothes, wash it off using soap and water.
- (3) Do not apply excessive force to the display surface or the adjoining areas since this may cause the color tone to vary. Do not touch the display with bare hands. This will stain the display area and degraded insulation between terminals (some cosmetics are determined to the polarizer).
- (4) The polarizer covering the display surface of the LCD module is soft and easily scratched. Handle this polarizer carefully. Do not touch, push or rub the exposed polarizers with anything harder than an HB pencil lead (glass, tweezers, etc.). Do not put or attach anything on the display area to avoid leaving marks on. Condensation on the surface and contact with terminals due to cold will damage, stain or dirty the polarizer. After products are tested at low temperature they must be warmed up in a container before coming is contacting with room temperature air.
- (5) If the display surface becomes contaminated, breathe on the surface and gently wipe it with a soft dry cloth. If it is heavily contaminated, moisten cloth with one of the following solvents
 - Isopropyl alcohol
 - Ethyl alcohol
 Do not scrub hard to avoid damaging the display surface.
- (6) Solvents other than those above-mentioned may damage the polarizer. Especially, do not use the following.

--	--

- Water
- Ketone
- Aromatic solvents

Wipe off saliva or water drops immediately, contact with water over a long period of time may cause deformation or color fading. Avoid contacting oil and fats.

(7) Exercise care to minimize corrosion of the electrode. Corrosion of the electrodes is accelerated by water droplets, moisture condensation or a current flow in a high-humidity environment.

(8) Install the LCD Module by using the mounting holes. When mounting the LCD module make sure it is free of twisting, warping and distortion. In particular, do not forcibly pull or bend the I/O cable or the backlight cable.

(9) Do not attempt to disassemble or process the LCD module.

(10) NC terminal should be open. Do not connect anything.

(11) If the logic circuit power is off, do not apply the input signals.

(12) Since LCM has been assembled and adjusted with a high degree of precision, avoid applying excessive shocks to the module or making any alterations or modifications to it.

- Do not alter, modify or change the shape of the tab on the metal frame.
- Do not make extra holes on the printed circuit board, modify its shape or change the positions of components to be attached.
- Do not damage or modify the pattern writing on the printed circuit board.
- Absolutely do not modify the zebra rubber strip (conductive rubber) or heat seal connector.
- Except for soldering the interface, do not make any alterations or modifications with a soldering iron.
- Do not drop, bend or twist LCM.

Storage Precautions

When storing the LCD modules, the following precaution is necessary.

(1) Store them in a sealed polyethylene bag. If properly sealed, there is no need for the dessicant.

(2) Store them in a dark place. Do not expose to sunlight or fluorescent light, keep the temperature between 0° C and 35° C.

(3) The polarizer surface should not come in contact with any other objects. (We advise you to store them in the container in which they were shipped).

Others

Liquid crystals solidify under low temperature (below the storage temperature range) leading to defective orientation or the generation of air bubbles (black or white). Air bubbles may also be generated if the module is subject to a low temperature.

If the LCD modules have been operating for a long time showing the same display patterns, the display patterns may remain on the screen as ghost images and a slight contrast irregularity may also appear. A normal operating status can be regained by suspending use for some time.

It should be noted that this phenomenon does not adversely affect performance reliability.

To minimize the performance degradation of the LCD modules resulting from destruction caused by static electricity etc., exercise care to avoid holding the following sections when handling the modules.



-
- Exposed area of the printed circuit board.
 - Terminal electrode sections.